

Data Sheet



Article number: 0108045

Description: Retaining ring JK 28 DIN 984

Measures

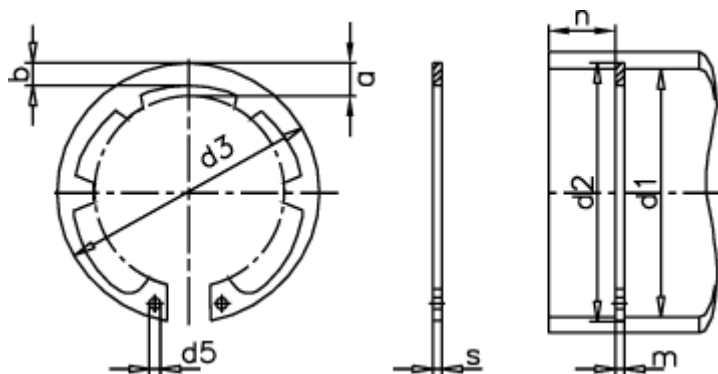

a max	= 4.9	FN kN	= 10.5	s	= 1.20
AN mm ²	= 63.1	FRg kN	= 4.5	t	= 0.70
b	= 3.0	FR kN	= 13.3	tol	= +0,21
d1	= 28	g	= 1.0	tol	= -0.06
d2	= 29.4	K kN-mm	= 26.3	tol	= +0,50-0,25
d3	= 30.1	m min	= 1.30	Tong	= ZGJ-2
d5 min	= 2.0	Nominal drive	= 2.1	Weight kg/1000	= 2.10
Description	= JK 28	Number of serrations	= 6		